

Liva 5

Tekniske spesifikationer:

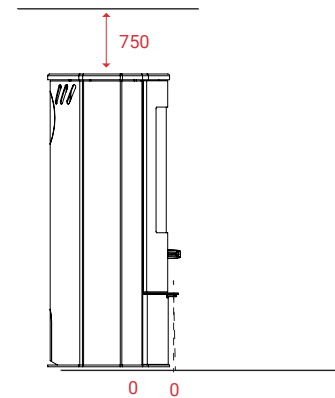

KG	121 kg
	12 PA
	5 kW
	30-120 m ²
Mg/M³	27
	1,56 kg
	78/68 %

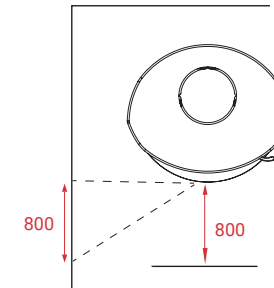
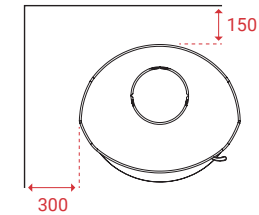
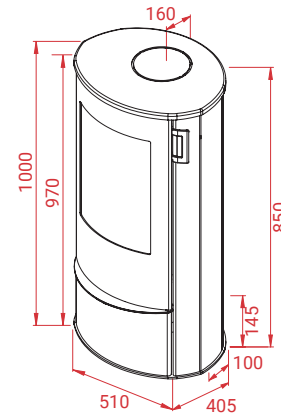

Tilbehør:



Andre modeller:

Liva 6
Liva 7G
Liva 8G

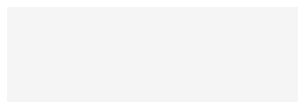

Se mere:



LOTUS HEATING SYSTEMS A/S

+45 6323 7070

info@lotusstoves.com

www.lotusstoves.com



Liva 5 Kleberstein



Tekniske spesifikationer:

175 kg
12 PA
5 kW
30-120 m ²
Mg/M³ 27
1,56 kg
78/68 %

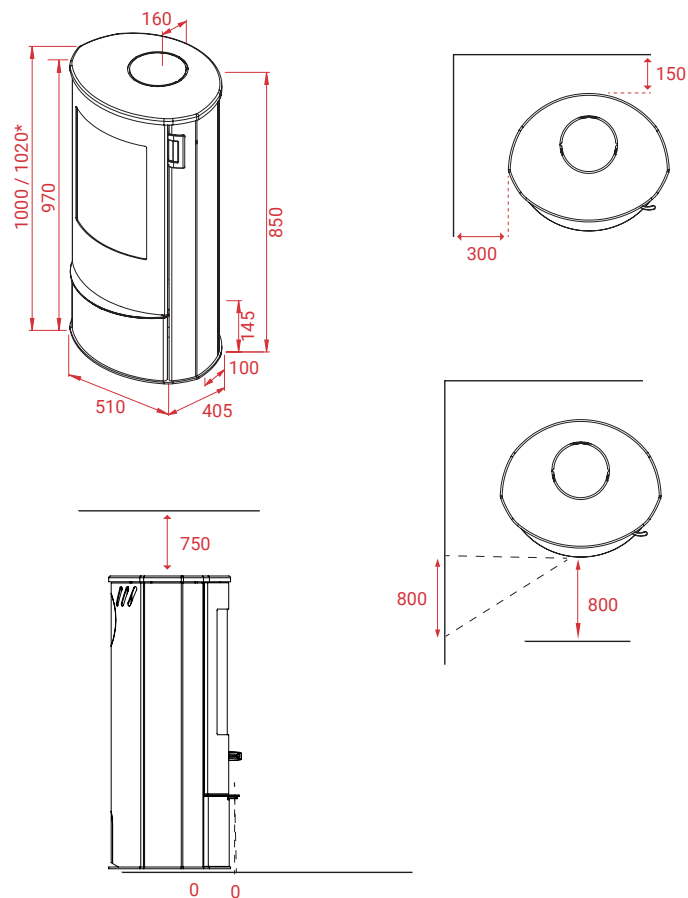

Tilbehør:



Andre modeller:

Liva 6
Liva 7G
Liva 8G

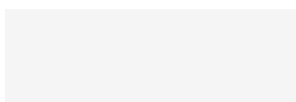

Se mere:



LOTUS HEATING SYSTEMS A/S
+45 6323 7070
info@lotusstoves.com
www.lotusstoves.com



Liva 5 Indian Night



Tekniske spesifikationer:

175 kg
12 PA
5 kW
30-120 m ²
Mg/M³ 27
1,56 kg
78/68 %

Liva 5 Indian Night

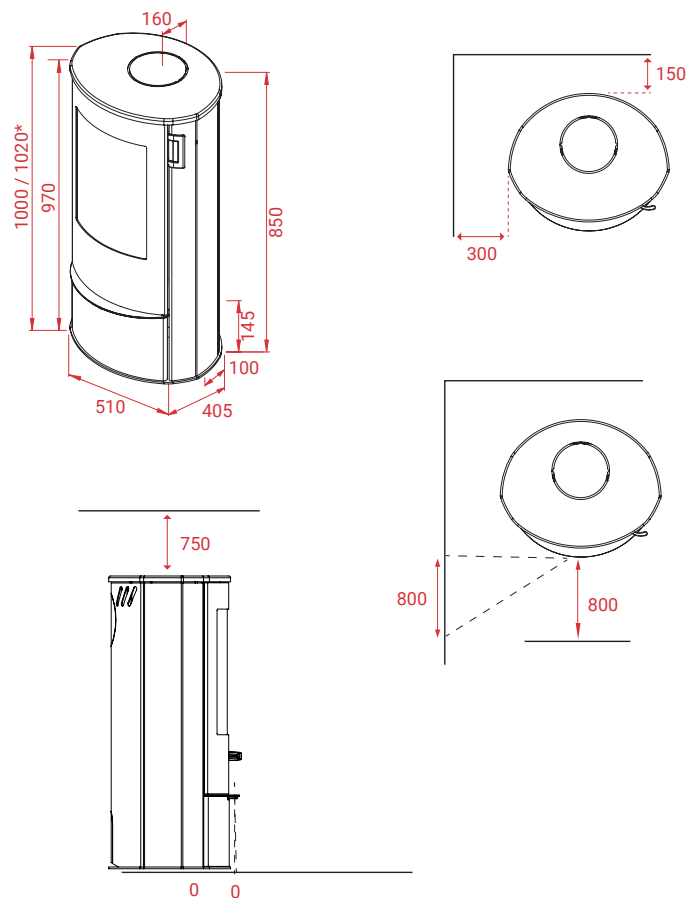

Tilbehør:



Andre modeller:

Liva 6
Liva 7G
Liva 8G

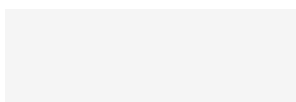

Se mere:



LOTUS HEATING SYSTEMS A/S

+45 6323 7070

info@lotusstoves.com

www.lotusstoves.com



Liva 5G



Tekniske specifikationer:

175 kg
12 PA
5 kW
30-120 m ²
Mg/M³ 27
1,56 kg
78/68 %

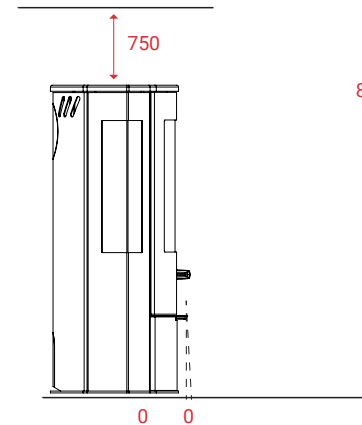
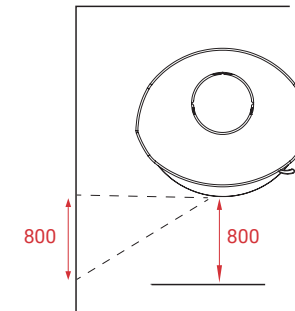
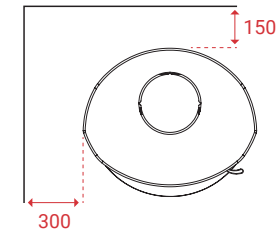
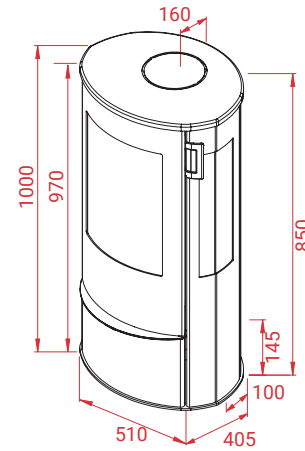

Tilbehør:



Andre modeller:

Liva 6
Liva 7G
Liva 8G

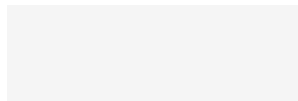

Se mere:



LOTUS HEATING SYSTEMS A/S

+45 6323 7070

info@lotusstoves.com

www.lotusstoves.com



Liva 6



Tekniske specifikationer:

133 kg
12 PA
5 kW
30-120 m ²
Mg/M³ 27
1,56 kg
78/68 %

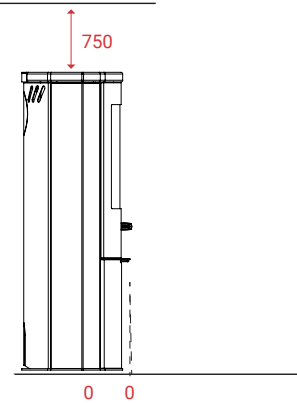
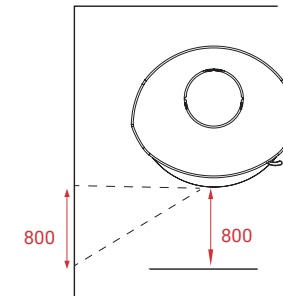
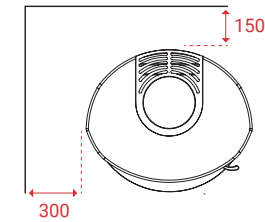
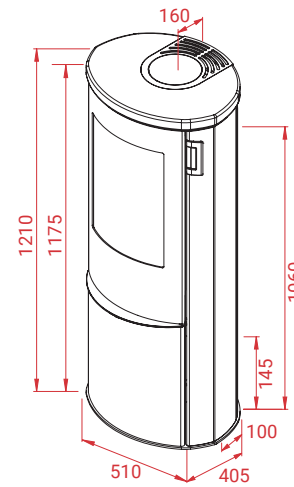

Tilbehør:



Andre modeller:

Liva 5
Liva 7G
Liva 8G

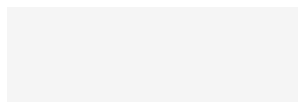

Se mere:



LOTUS HEATING SYSTEMS A/S

+45 6323 7070

info@lotusstoves.com

www.lotusstoves.com



Liva 6 Kleberstein



Tekniske specifikationer:

KG	192 kg
12 PA	
5 kW	
30-120 m²	
Mg/M³	27
1,56 kg	
78/68 %	

Liva 6 Kleberstein

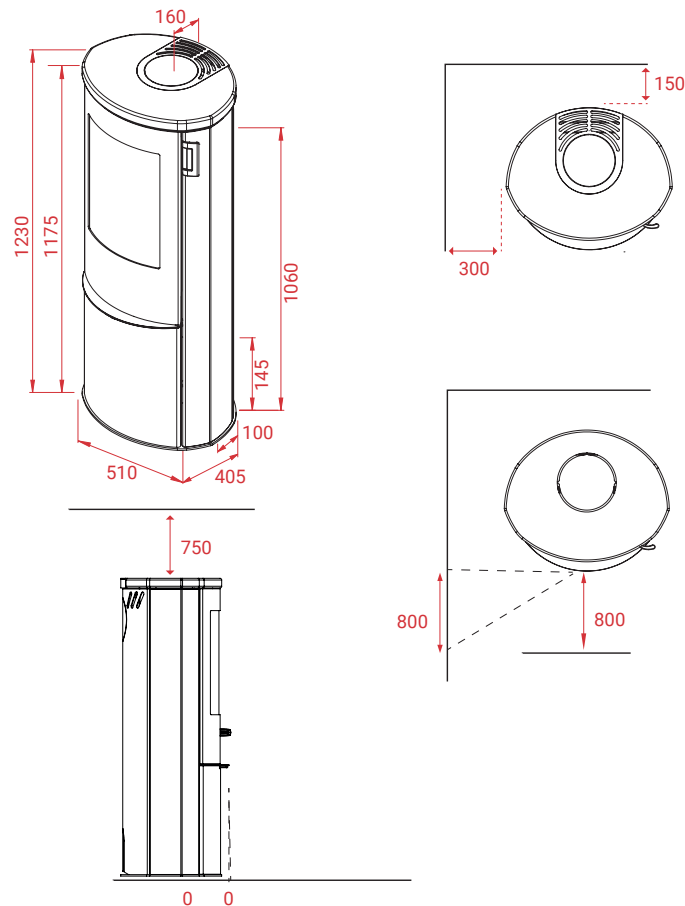

Tilbehør:



Andre modeller:

Liva 5
Liva 7G
Liva 8G

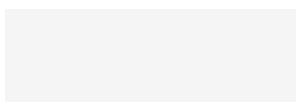

Se mere:



LOTUS HEATING SYSTEMS A/S

+45 6323 7070

info@lotusstoves.com

www.lotusstoves.com



Liva 6 Indian Night



Tekniske specifikationer:

KG	192 kg
12 PA	
5 kW	
30-120 m²	
Mg/M³	27
1,56 kg	
78/68 %	

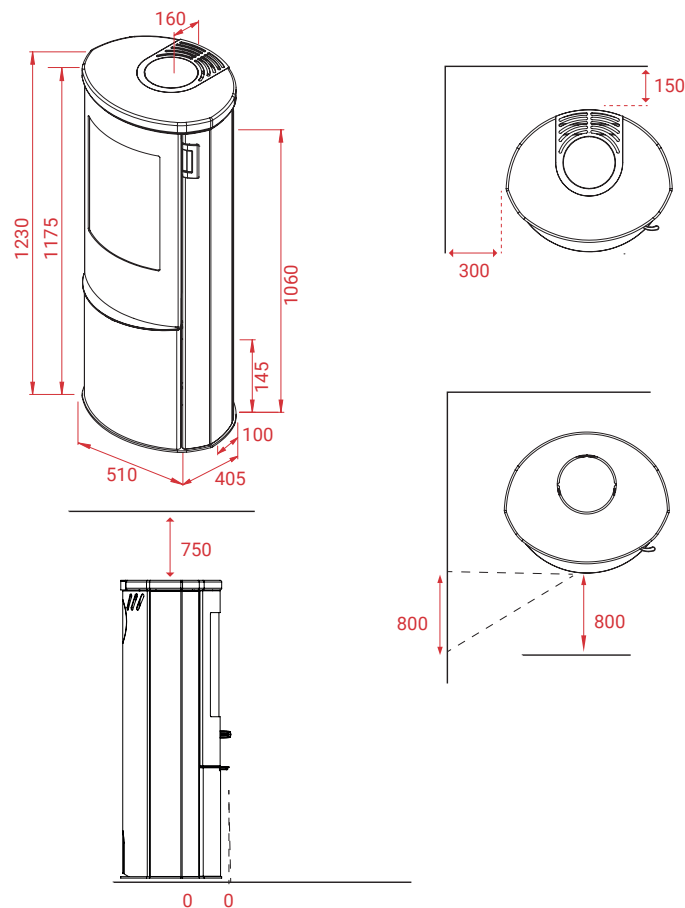

Tilbehør:



Andre modeller:

Liva 5
Liva 7G
Liva 8G

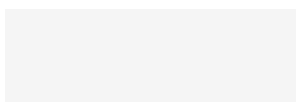

Se mere:



LOTUS HEATING SYSTEMS A/S

+45 6323 7070

info@lotusstoves.com

www.lotusstoves.com



Liva 6G



Tekniske specifikationer:

KG	192 kg
12 PA	12 PA
5 kW	5 kW
30-120 m²	30-120 m ²
Mg/M³	27
1,56 kg	1,56 kg
78/68 %	78/68 %

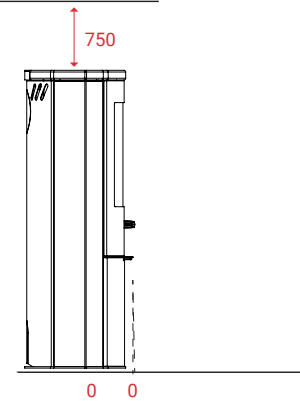
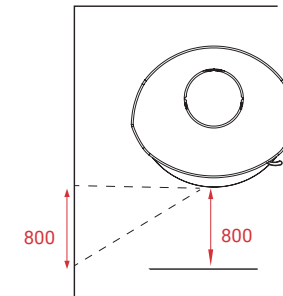
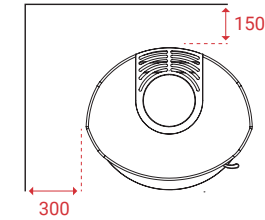
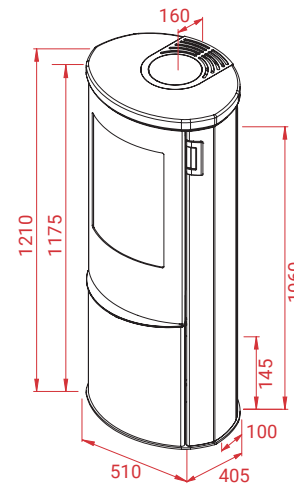

Tilbehør:



Andre modeller:

Liva 5
Liva 7G
Liva 8G

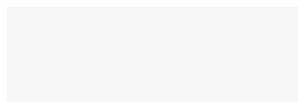

Se mere:



LOTUS HEATING SYSTEMS A/S

+45 6323 7070

info@lotusstoves.com







www.lotusstoves.com



Liva 7G

Tekniske specifikationer:



 167 kg
 12 PA
 5 kW
 30-120 m ²
Mg/M³ 27
 1,56 kg
 78/68 %

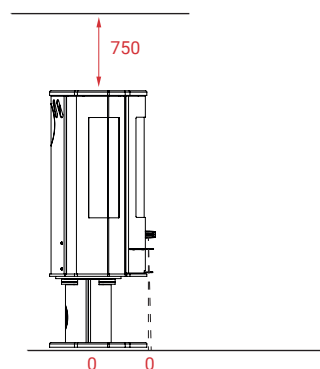
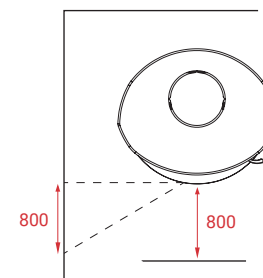
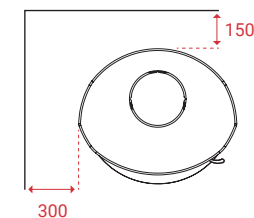
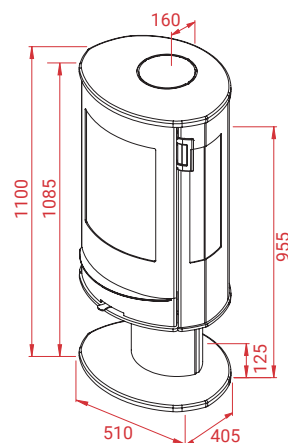

Tilbehør:



Andre modeller:

Liva 5
Liva 6
Liva 8G

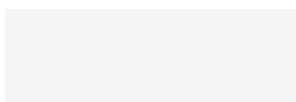

Se mere:



LOTUS HEATING SYSTEMS A/S

+45 6323 7070

info@lotusstoves.com

www.lotusstoves.com



Liva 8G

Tekniske specifikationer:



120 kg
12 PA
5 kW
30-120 m ²
Mg/M³ 27
1,56 kg
78/68 %

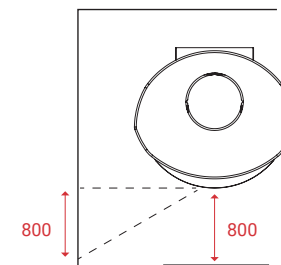
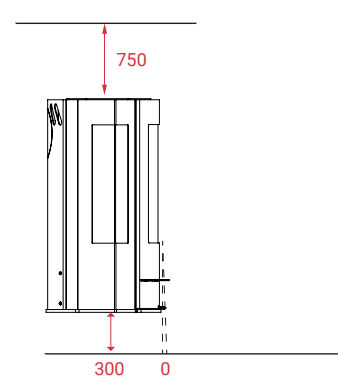
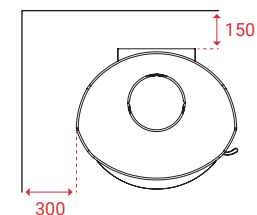
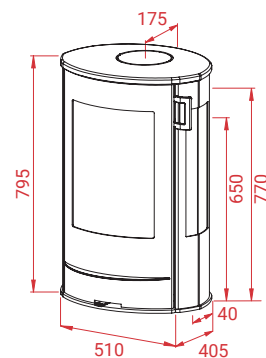

Tilbehør:



Andre modeller:

Liva 5
Liva 6
Liva 8G

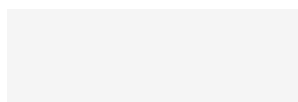

Se mere:



LOTUS HEATING SYSTEMS A/S

+45 6323 7070

info@lotusstoves.com

www.lotusstoves.com

