







M Basic



Tekniske specifikationer:

| |
|---|
|  413 kg |
|  12 PA |
|  5,9 kW |
|  30-120 m ² |
| Mg/M³ 24 |
|  2,02 kg |
|  83/73 % |

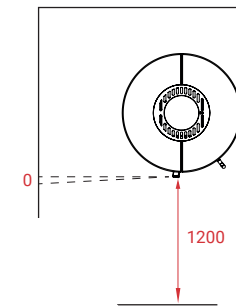
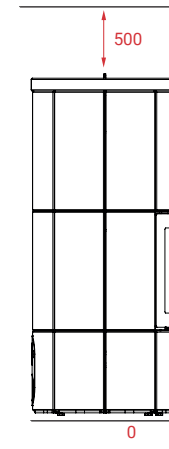
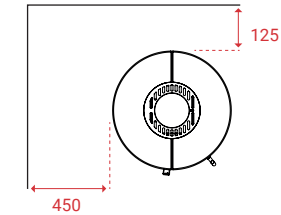
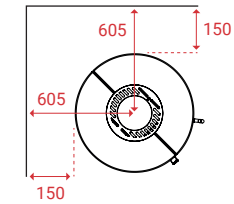
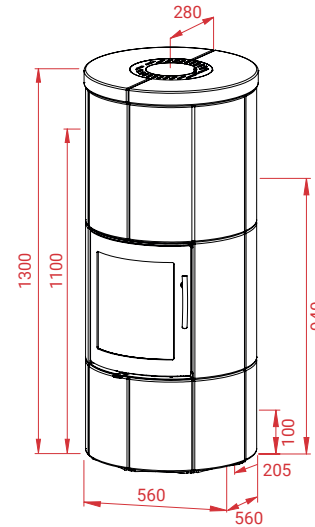

Tilbehør:

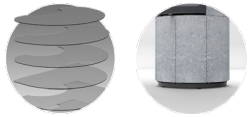

Andre modeller:

M1
M2
M3

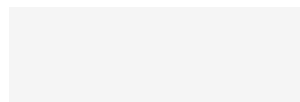

Se mere:



LOTUS HEATING SYSTEMS A/S

+45 6323 7070

info@lotusstoves.com







www.lotusstoves.com



M1 Kleberstein



Tekniske specifikationer:

| |
|---|
|  370 kg |
|  12 PA |
|  5,9 kW |
|  30-120 m ² |
| Mg/M³ 24 |
|  2,02 kg |
|  83/73 % |

M1 Kleberstein

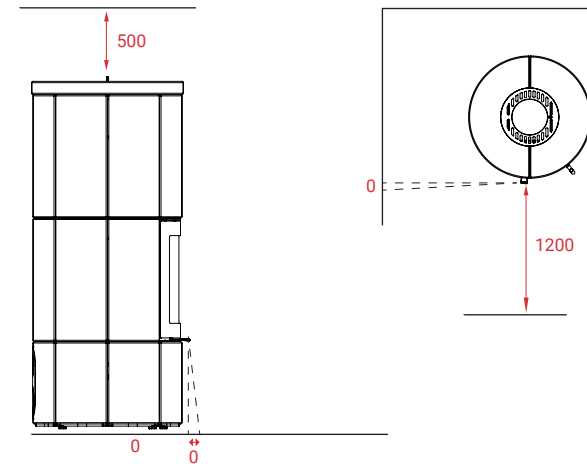
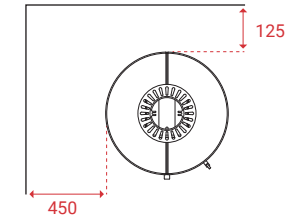
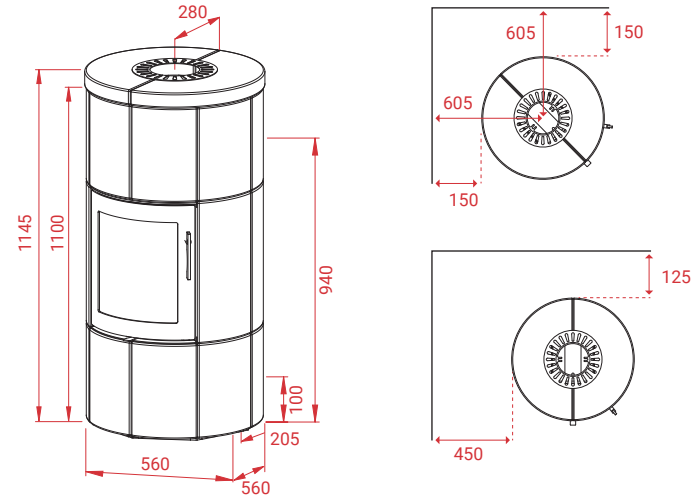

Tilbehør:

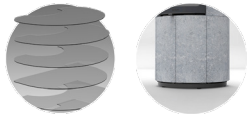

Andre modeller:

M Basic
M2
M3

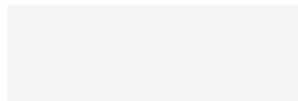

Se mere:



LOTUS HEATING SYSTEMS A/S

+45 6323 7070

info@lotusstoves.com







www.lotusstoves.com



M1 Indian Night



Tekniske specifikationer:

| | |
|---|-----------------------|
|  KG | 370 kg |
|  12 PA | 12 PA |
|  5,9 kW | 5,9 kW |
|  30-120 m² | 30-120 m ² |
| Mg/M³ | 24 |
|  2,02 kg | 2,02 kg |
|  83/73 % | 83/73 % |

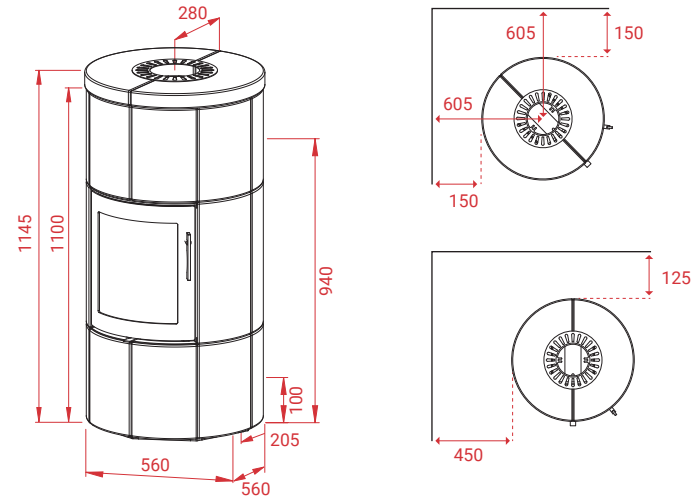

Tilbehør:

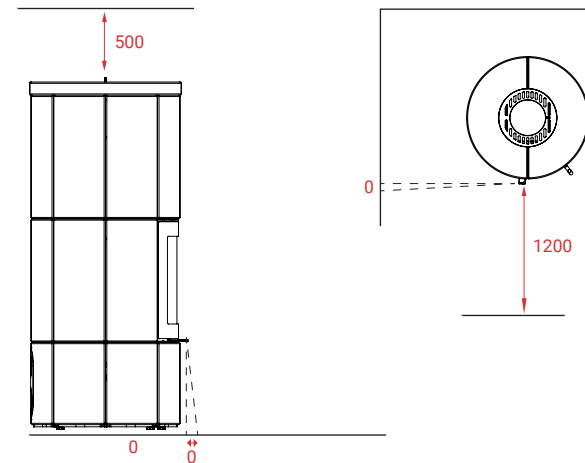
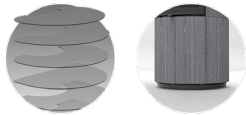

Andre modeller:

M Basic
M2
M3

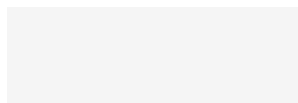

Se mere:



LOTUS HEATING SYSTEMS A/S

+45 6323 7070

info@lotusstoves.com







www.lotusstoves.com



M2 Kleberstein



Tekniske spesifikationer:

| | |
|---|-----------------------|
|  KG | 497 kg |
|  | 12 PA |
|  | 5,9 kW |
|  | 30-120 m ² |
| Mg/M² | 24 |
|  | 2,02 kg |
|  | 83/73 % |

Tilbehør:

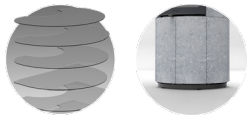

M2 Kleberstein

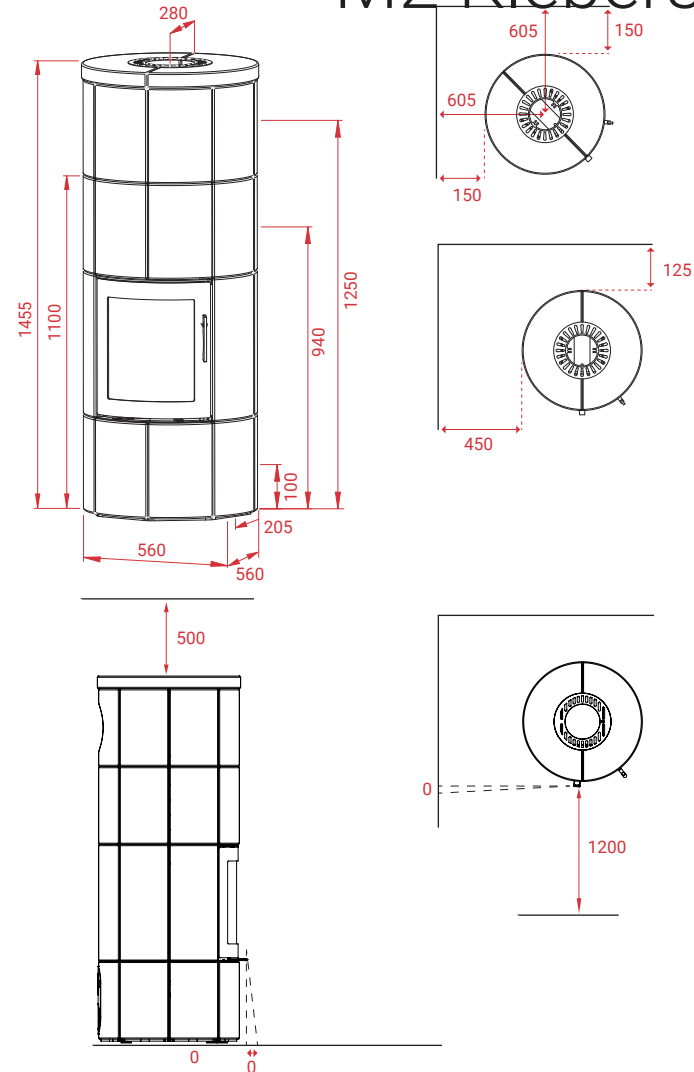

Andre modeller:

M Basic
M1
M3

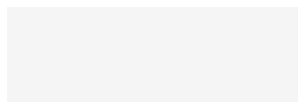

Se mere:



LOTUS HEATING SYSTEMS A/S

+45 6323 7070

info@lotusstoves.com







www.lotusstoves.com



M2 Indian Night



Tekniske spesifikasjoner:

| | |
|--|-----------|
|  KG | 497 kg |
|  12 PA | 12 PA |
|  5,9 kW | 5,9 kW |
|  30-120 m² | 30-120 m² |
| Mg/M³ | 24 |
|  2,02 kg | 2,02 kg |
|  83/73 % | 83/73 % |

Tilbehør:

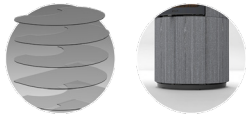

M2 Indian Night

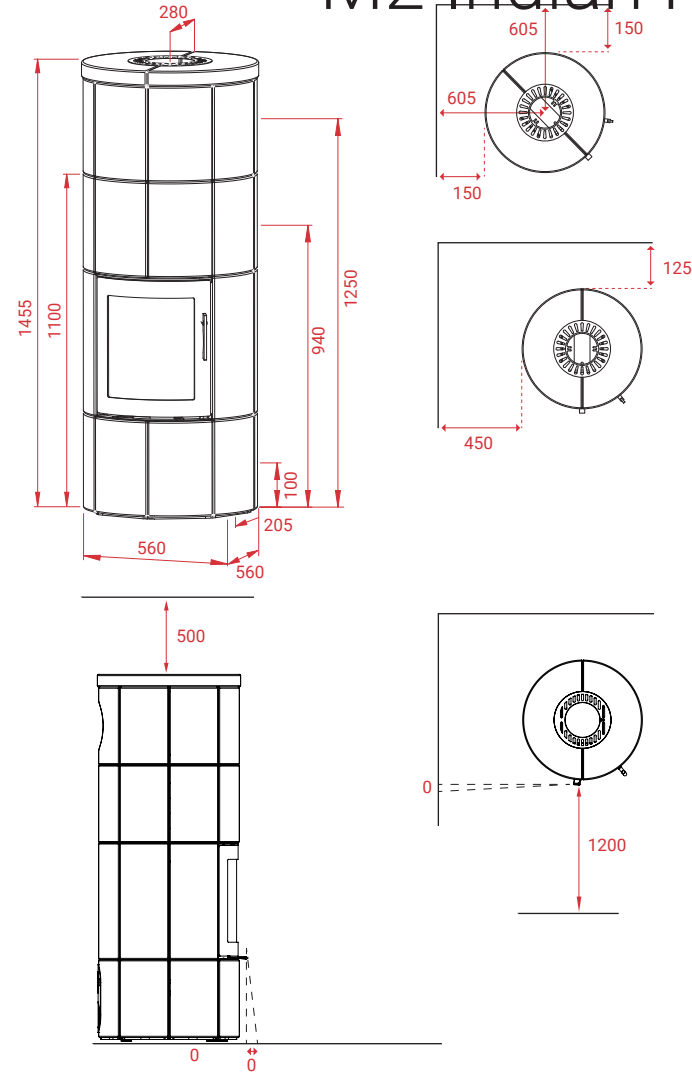

Andre modeller:

- M Basic
- M1
- M3

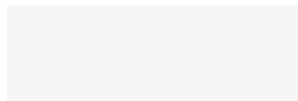

Se mere:



LOTUS HEATING SYSTEMS A/S

+45 6323 7070

info@lotusstoves.com







www.lotusstoves.com



M3 Kleberstein



Tekniske spesifikasjoner:

| | |
|---|-----------------------|
|  KG | 625 kg |
|  | 12 PA |
|  | 5,9 kW |
|  | 30-120 m ² |
| Mg/M³ | 24 |
|  | 2,02 kg |
|  | 83/73 % |

Tilbehør:

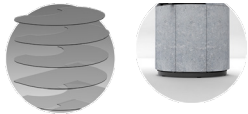

Andre modeller:

M Basic
M1
M2

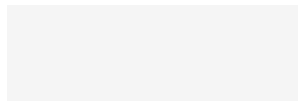

M3 Kleberstein

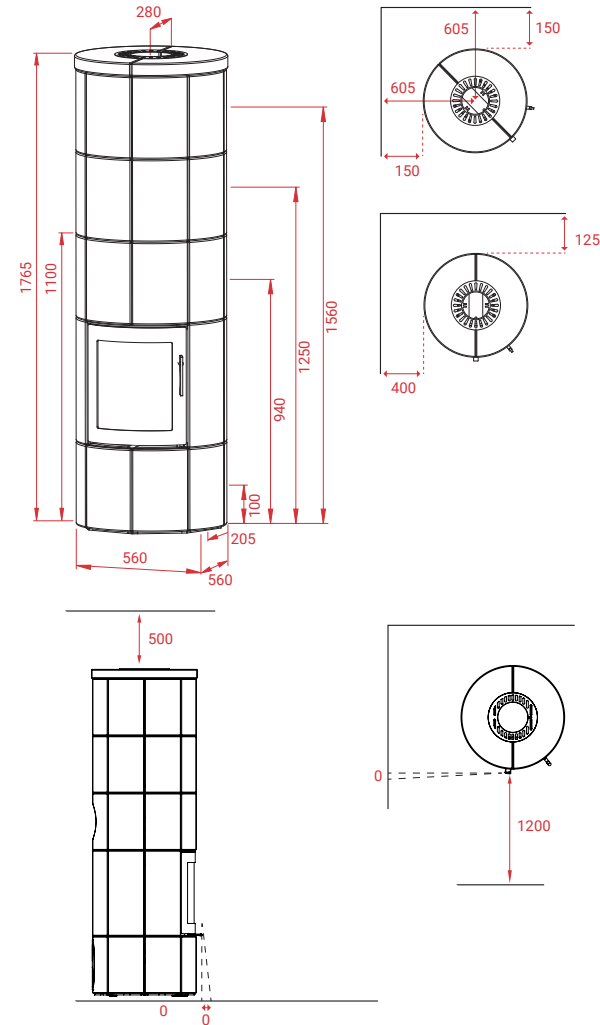

Se mere:



LOTUS HEATING SYSTEMS A/S

+45 6323 7070

info@lotusstoves.com







www.lotusstoves.com



M3 Indian Night



Tekniske specifikationer:

| | |
|---|-----------------------|
|  KG | 625 kg |
|  12 PA | 12 PA |
|  5,9 kW | 5,9 kW |
|  30-120 m² | 30-120 m ² |
| Mg/M³ | 24 |
|  2,02 kg | 2,02 kg |
|  83/73 % | 83/73 % |

Tilbehør:

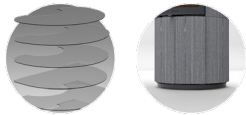

M3 Indian Night

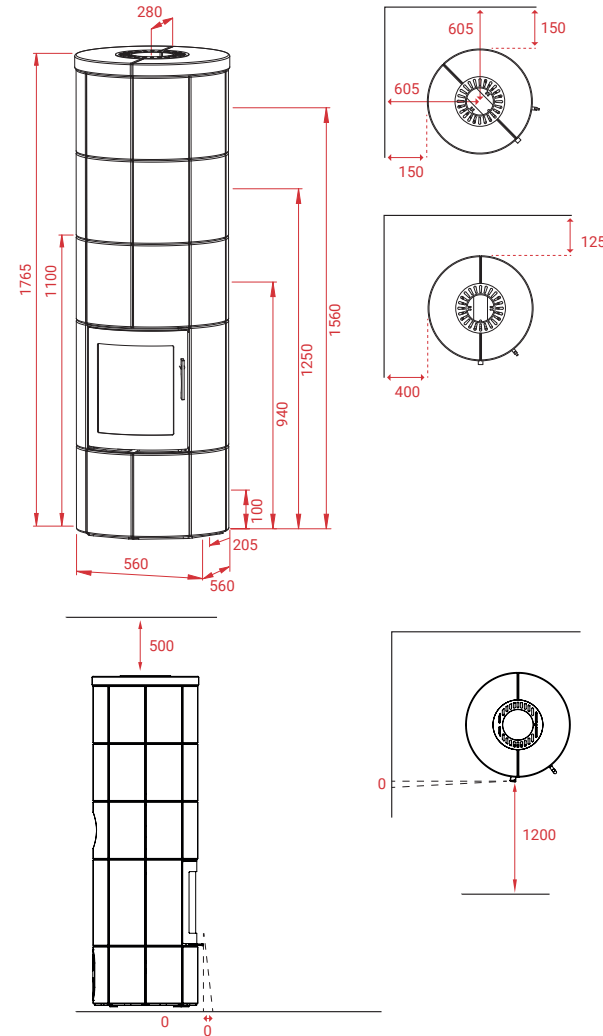

Andre modeller:

M Basic
M1
M2

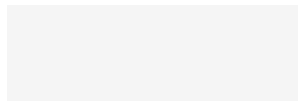

Se mere:



LOTUS HEATING SYSTEMS A/S

+45 6323 7070

info@lotusstoves.com







www.lotusstoves.com



M Basic ecoLine



Tekniske specifikationer:

| | |
|---|-----------------------|
|  KG | 413 kg |
|  12 PA | 12 PA |
|  5,9 kW | 5,9 kW |
|  30-120 m² | 30-120 m ² |
| Mg/M³ | 24 |
|  2,02 kg | 2,02 kg |
|  86/76 % | 86/76 % |

Tilbehør:

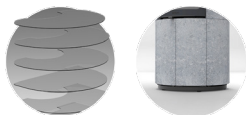

Andre modeller:

M1 ecoLine
M2 ecoLine
M3 ecoLine

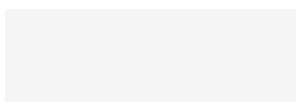

M Basic ecoLine

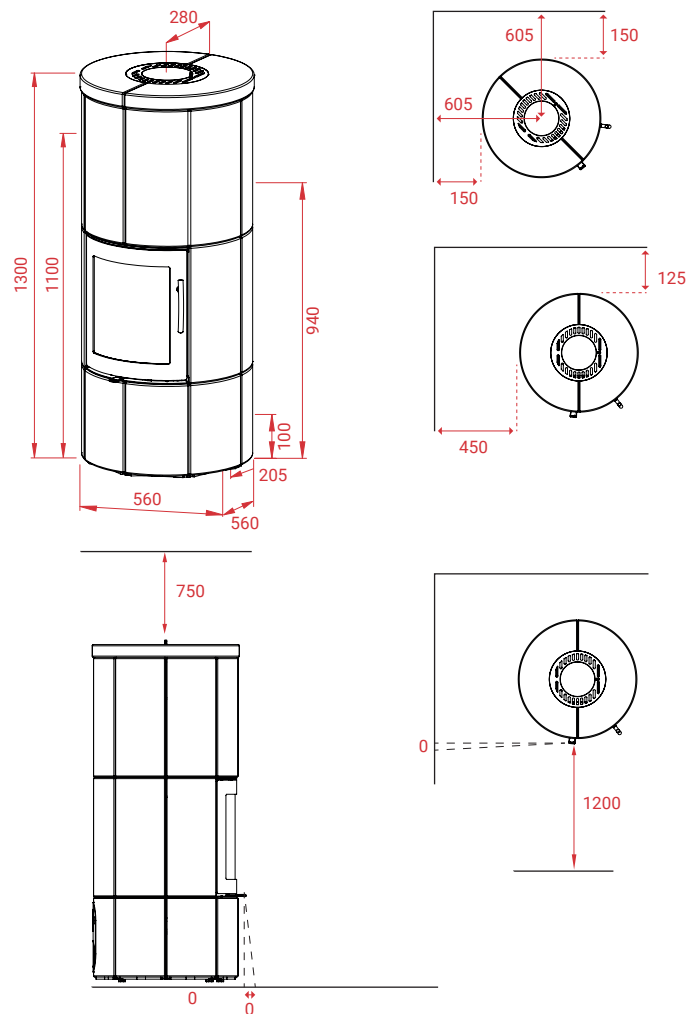

Se mere:



LOTUS HEATING SYSTEMS A/S

+45 6323 7070

info@lotusstoves.com







www.lotusstoves.com



M1 Kleberstein ecoLine



Tekniske specifikationer:

| | |
|--|-----------|
|  KG | 370 kg |
|  12 PA | 12 PA |
|  5,5 kW | 5,5 kW |
|  30-120 m² | 30-120 m² |
| Mg/M³ | 12 |
|  1,55 kg | 1,55 kg |
|  86/76 % | 86/76 % |

M1 Kleberstein ecoLine

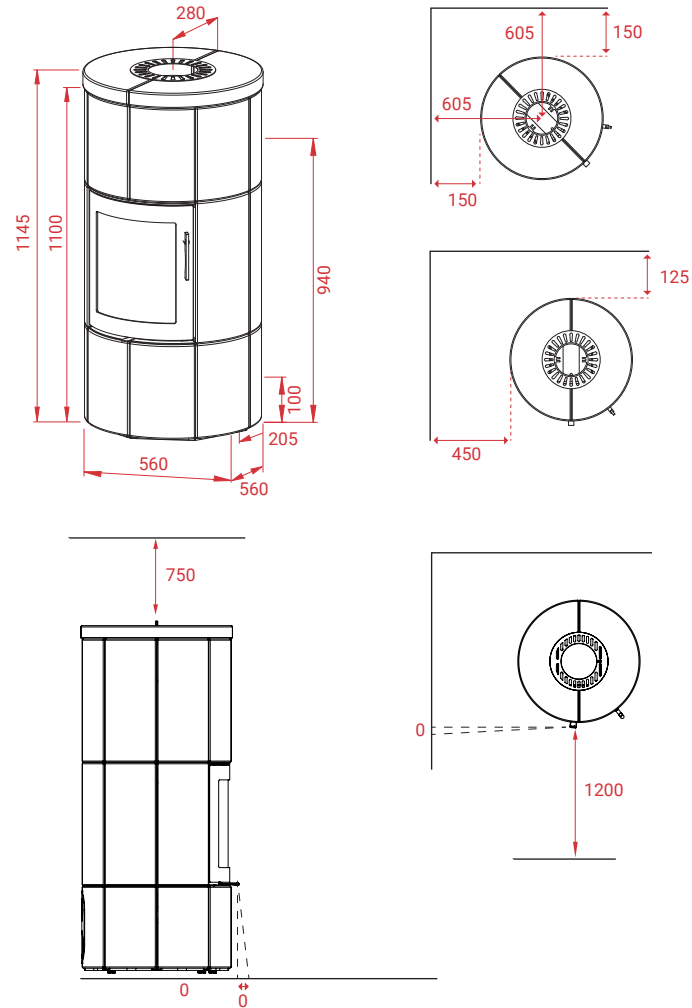

Tilbehør:

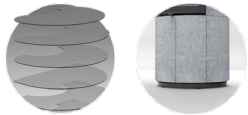

Andre modeller:

- M Basic ecoLine
- M2 ecoLine
- M3 ecoLine

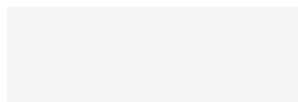

Se mere:



LOTUS HEATING SYSTEMS A/S

+45 6323 7070

info@lotusstoves.com







www.lotusstoves.com



M1 Indian Night ecoLine



Tekniske specifikationer:

| | |
|---|-----------------------|
|  KG | 370 kg |
|  12 PA | 12 PA |
|  5,5 kW | 5,5 kW |
|  30-120 m² | 30-120 m ² |
| Mg/M³ | 12 |
|  1,55 kg | 1,55 kg |
|  86/76 % | 86/76 % |

M1 Indian Night ecoLine

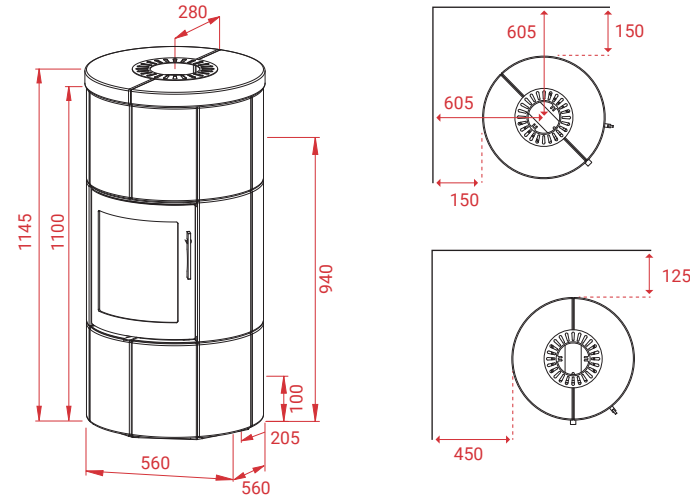

Tilbehør:

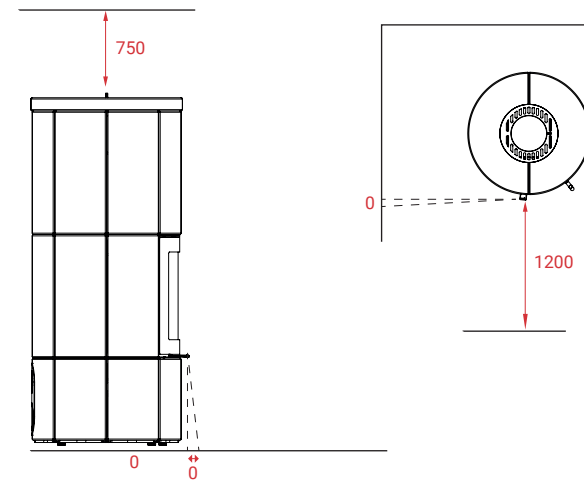
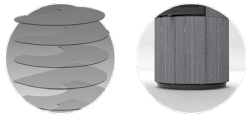

Andre modeller:

- M Basic ecoLine
- M2 ecoLine
- M3 ecoLine

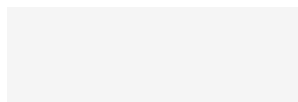

Se mere:



LOTUS HEATING SYSTEMS A/S

+45 6323 7070

info@lotusstoves.com

www.lotusstoves.com



M2 Kleberstein ecoLine



Tekniske spesifikasjoner:

| | |
|-------------------------|-----------------------|
| | 497 kg |
| | 12 PA |
| | 5,5 kW |
| | 30-120 m ² |
| Mg/M³ | 12 |
| | 1,55 kg |
| | 86/76 % |

Tilbehør:

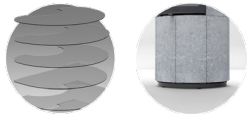

M2 Kleberstein ecoLine

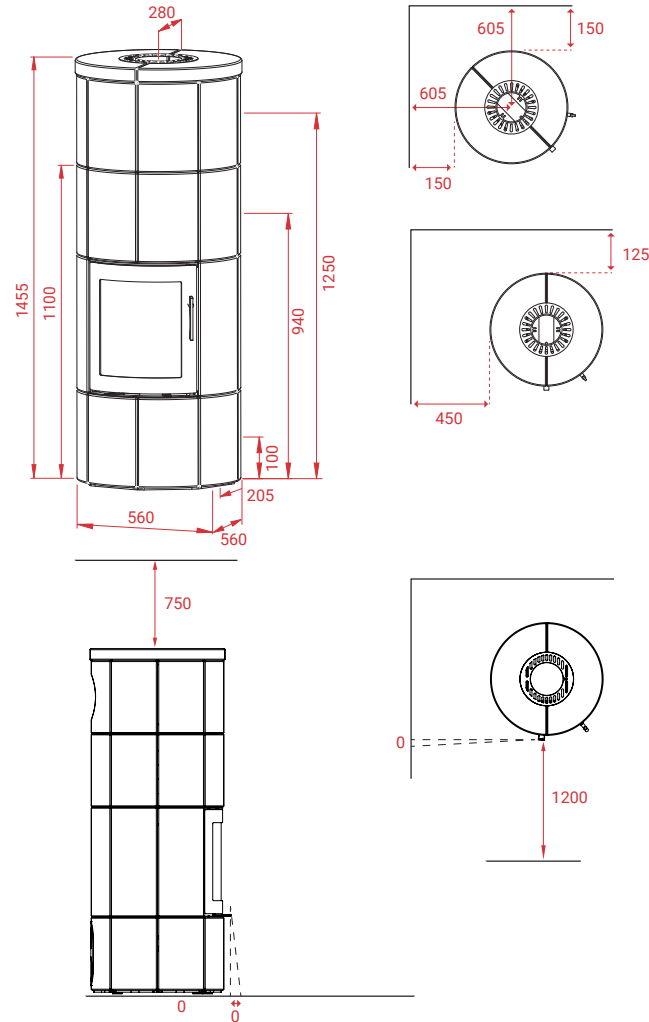

Andre modeller:

M Basic ecoLine
M1 ecoLine
M3 ecoLine

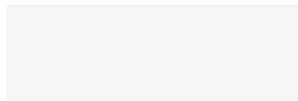

Se mere:



LOTUS HEATING SYSTEMS A/S

+45 6323 7070

info@lotusstoves.com







www.lotusstoves.com



M2 Indian Night ecoLine



Tekniske spesifikationer:

| | |
|---|-----------------------|
|  KG | 497 kg |
|  | 12 PA |
|  | 5,5 kW |
|  | 30-120 m ² |
| Mg/M³ | 12 |
|  | 1,55 kg |
|  | 86/76 % |

Tilbehør:

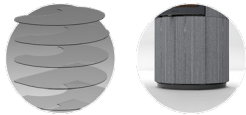

M2 Indian Night ecoLine

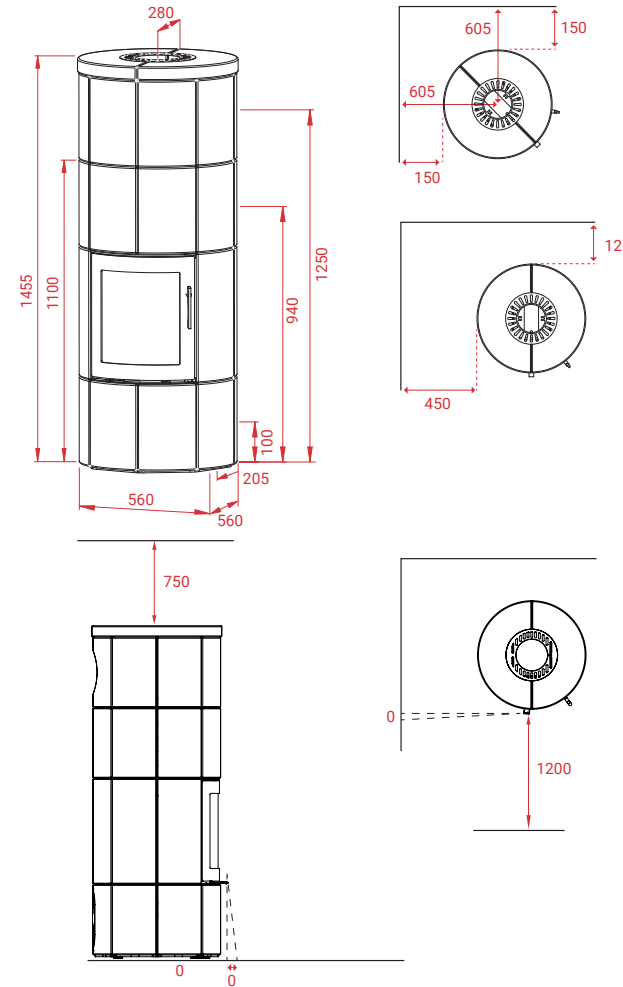

Andre modeller:

- M Basic ecoLine
- M1 ecoLine
- M3 ecoLine

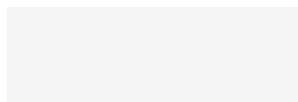

Se mere:



LOTUS HEATING SYSTEMS A/S

+45 6323 7070

info@lotusstoves.com

www.lotusstoves.com



M3 Kleberstein ecoLine



Tekniske spesifikationer:

| | |
|-------------------------|-----------------------|
| | 625 kg |
| | 12 PA |
| | 5,5 kW |
| | 30-120 m ² |
| Mg/M³ | 12 |
| | 1,55 kg |
| | 86/76 % |

Tilbehør:

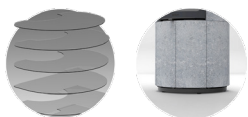

M3 Kleberstein ecoLine

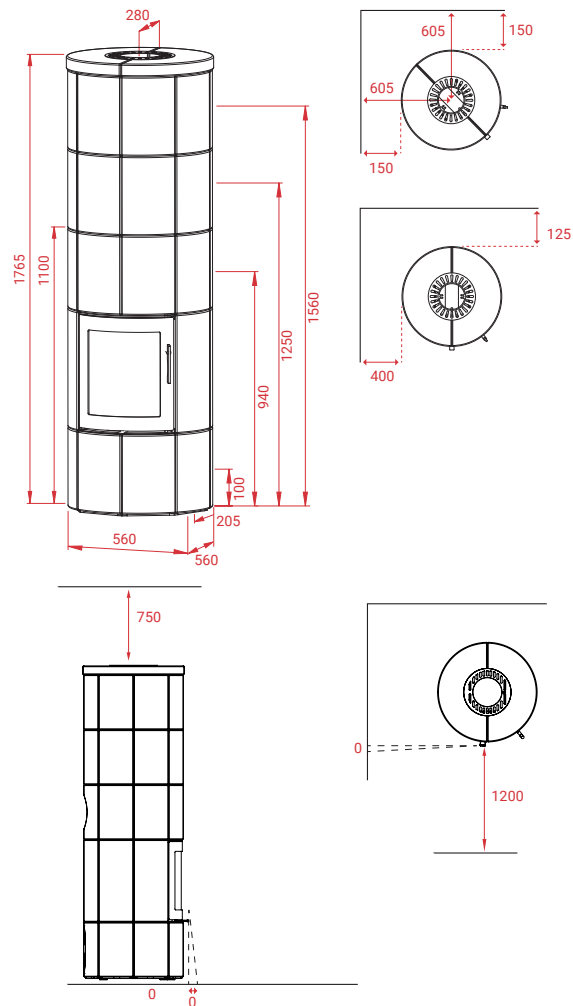

Andre modeller:

M Basic ecoLine
M1 ecoLine
M2 ecoLine

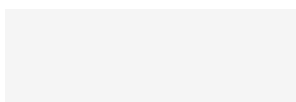

Se mere:



LOTUS HEATING SYSTEMS A/S

+45 6323 7070

info@lotusstoves.com







www.lotusstoves.com



M3 Indian Night ecoLine



Tekniske spesifikationer:

| | |
|---|-----------------------|
|  KG | 625 kg |
|  | 12 PA |
|  | 5,5 kW |
|  | 30-120 m ² |
| Mg/M³ | 12 |
|  | 1,55 kg |
|  | 86/76 % |

Tilbehør:

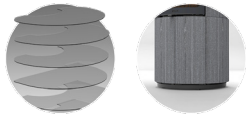

M3 Indian Night ecoLine

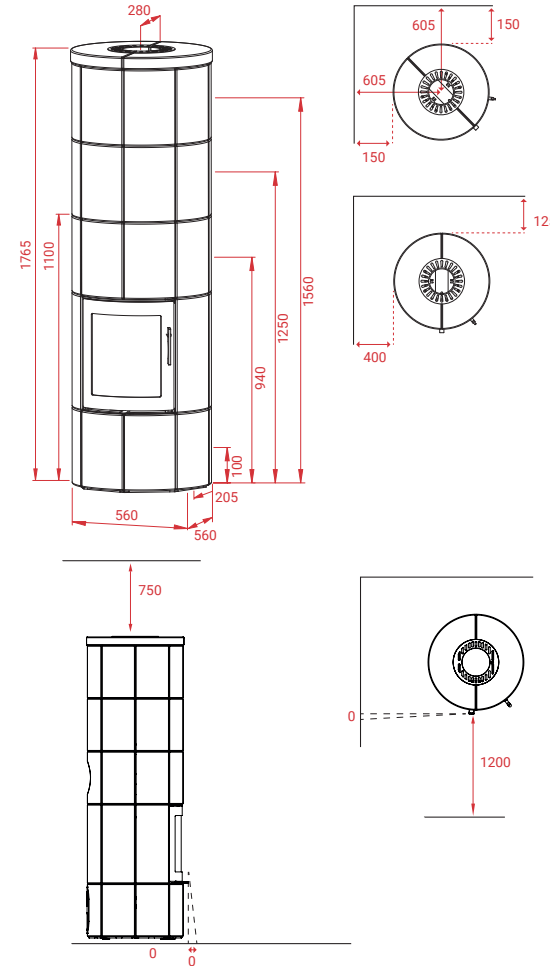

Andre modeller:

M Basic ecoLine
M1 ecoLine
M2 ecoLine

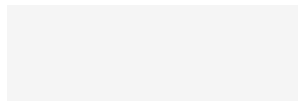

Se mere:



LOTUS HEATING SYSTEMS A/S

+45 6323 7070

info@lotusstoves.com

www.lotusstoves.com

