







M Basic



Caractéristiques techniques:

 KG	413 kg
 12 PA	12 PA
 5,9 kW	5,9 kW
 30-120 m²	30-120 m ²
Mg/M³	24
 2,02 kg	2,02 kg
 83/73 %	83/73 %

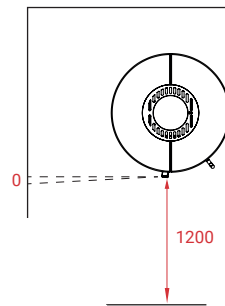
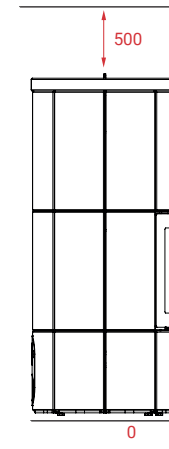
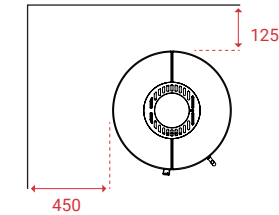
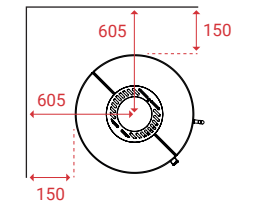
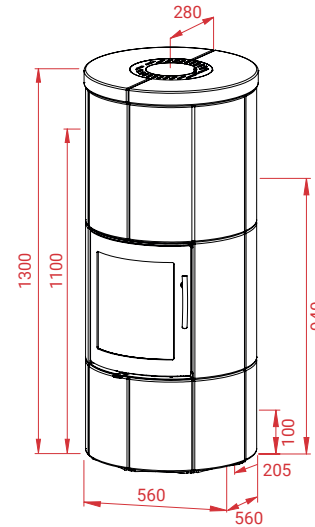

Accessoires:

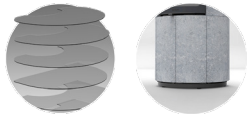

Autres modèles:

- M1
- M2
- M3

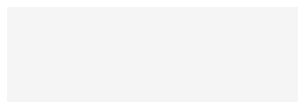

En savoir plus:



LOTUS HEATING SYSTEMS A/S

+45 6323 7070

info@lotusstoves.com







www.lotusstoves.com



M1 Pierre ollaire



Caractéristiques techniques:

 KG	370 kg
 12 PA	12 PA
 5,9 kW	5,9 kW
 30-120 m²	30-120 m²
Mg/M³	24
 2,02 kg	2,02 kg
 83/73 %	83/73 %

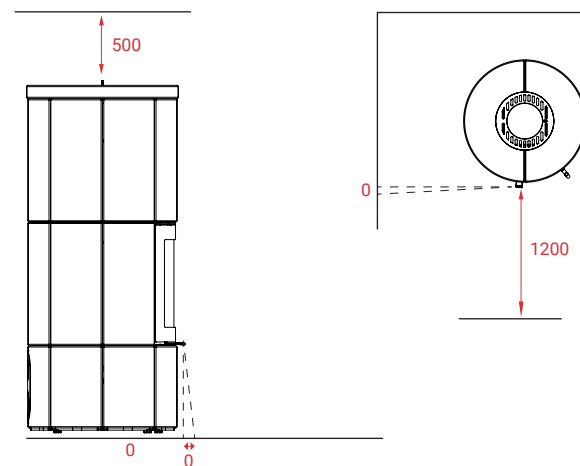
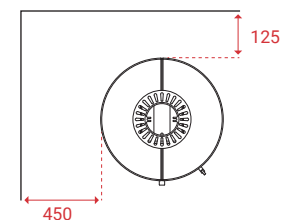
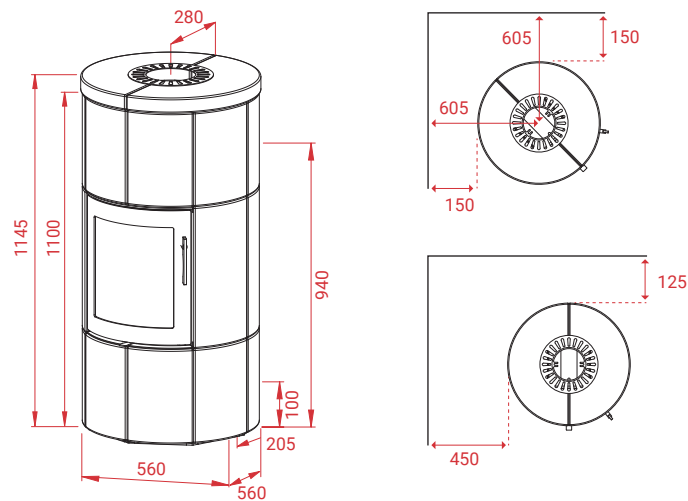

Accessoires:

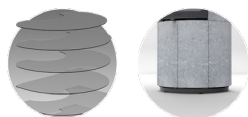

Autres modèles:

M Basic
M2
M3

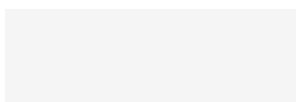

En savoir plus:



LOTUS HEATING SYSTEMS A/S

+45 6323 7070

info@lotusstoves.com

www.lotusstoves.com



M1 Indian Night



Caractéristiques techniques:

370 kg
12 PA
5,9 kW
30-120 m ²
Mg/M³ 24
2,02 kg
83/73 %

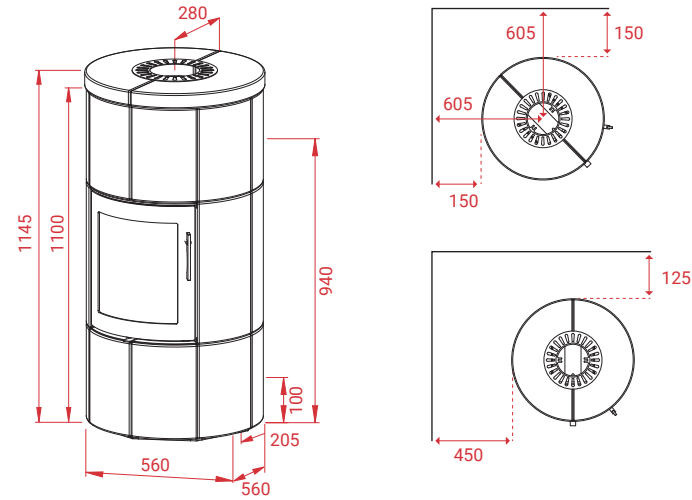

Accessoires:

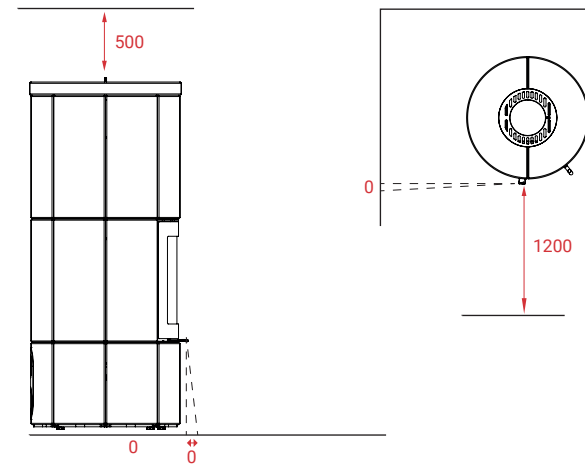
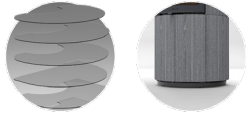

Autres modèles:

- M Basic
- M2
- M3

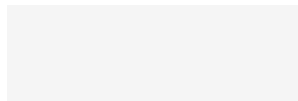

En savoir plus:



LOTUS HEATING SYSTEMS A/S

+45 6323 7070

info@lotusstoves.com







www.lotusstoves.com



M2 Pierre ollaire



Caractéristiques techniques:

 KG	497 kg
 12 PA	12 PA
 5,9 kW	5,9 kW
 30-120 m²	30-120 m²
Mg/M³	24
 2,02 kg	2,02 kg
 83/73 %	83/73 %

Accessoires:

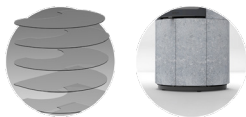

M2 Pierre ollaire

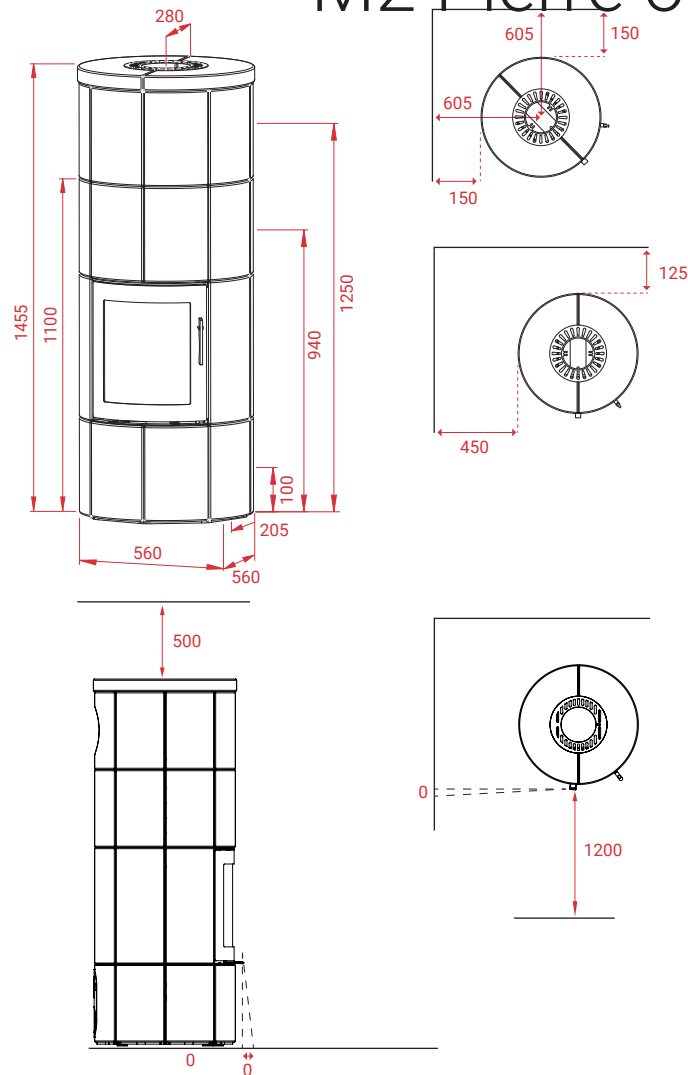

Autres modèles:

M Basic
M1
M3

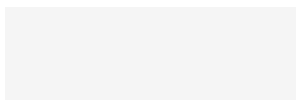

En savoir plus:



LOTUS HEATING SYSTEMS A/S

+45 6323 7070

info@lotusstoves.com







www.lotusstoves.com



M2 Indian Night



Caractéristiques techniques:

 KG	497 kg
 12 PA	12 PA
 5,9 kW	5,9 kW
 30-120 m²	30-120 m²
Mg/M³	24
 2,02 kg	2,02 kg
 83/73 %	83/73 %

Accessoires:

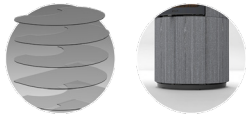

Autres modèles:

M Basic
M1
M3

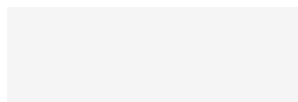

M2 Indian Night

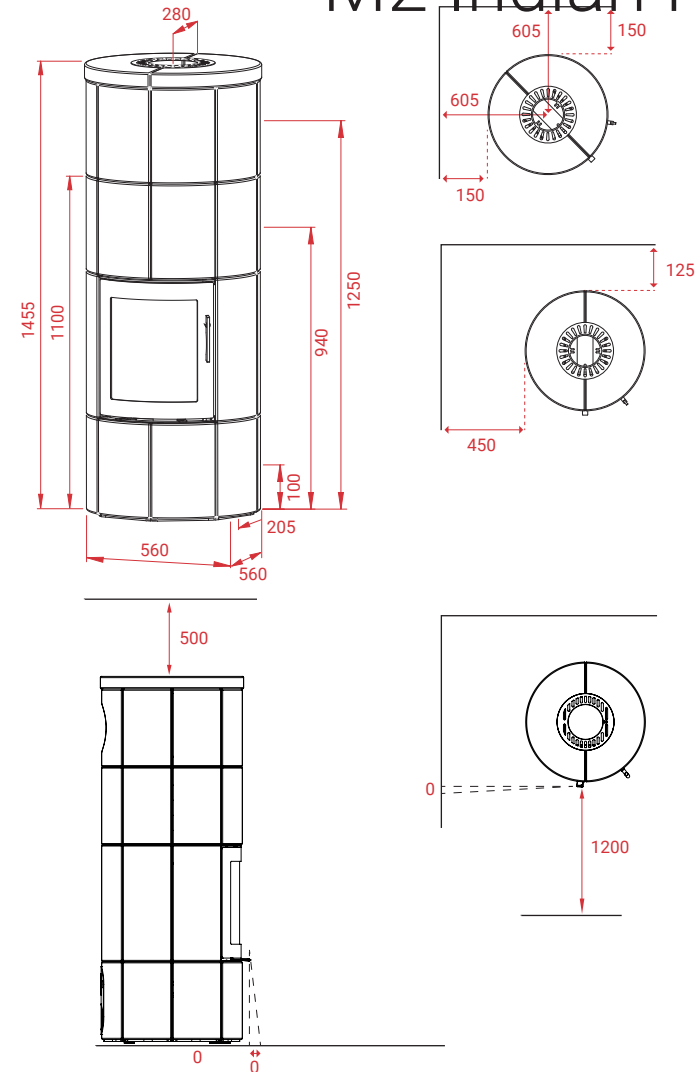

En savoir plus:



LOTUS HEATING SYSTEMS A/S

+45 6323 7070

info@lotusstoves.com







www.lotusstoves.com



M3 Pierre ollaire



Caractéristiques techniques:

 KG	625 kg
	12 PA
	5,9 kW
	30-120 m ²
Mg/M³	24
	2,02 kg
	83/73 %

Accessoires:

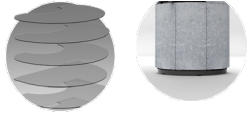

Autres modèles:

M Basic
M1
M2

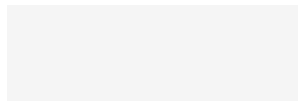

M3 Pierre ollaire

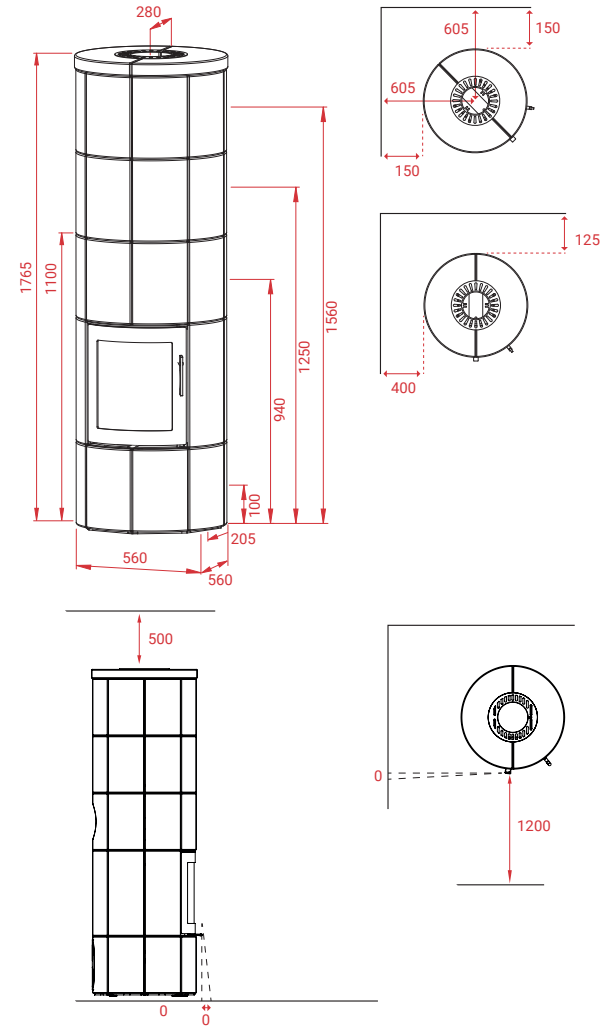

En savoir plus:



LOTUS HEATING SYSTEMS A/S

+45 6323 7070

info@lotusstoves.com







www.lotusstoves.com



M3 Indian Night



Caractéristiques techniques:

 KG	625 kg
 12 PA	12 PA
 5,9 kW	5,9 kW
 30-120 m²	30-120 m²
Mg/M³	24
 2,02 kg	2,02 kg
 83/73 %	83/73 %

Accessoires:

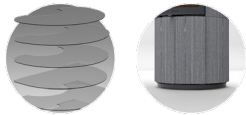

Autres modèles:

M Basic
M1
M2

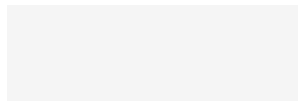

M3 Indian Night

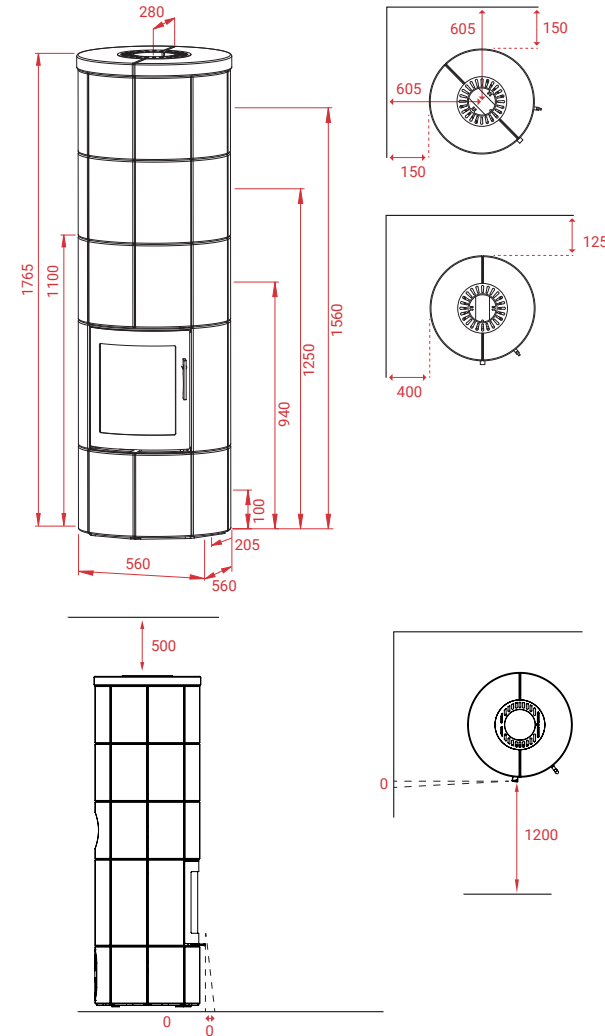

En savoir plus:



LOTUS HEATING SYSTEMS A/S

+45 6323 7070

info@lotusstoves.com







www.lotusstoves.com



M Basic ecoLine



Caractéristiques techniques:

 KG	413 kg
 12 PA	12 PA
 5,9 kW	5,9 kW
 30-120 m²	30-120 m ²
Mg/M³	24
 2,02 kg	2,02 kg
 86/76 %	86/76 %

Accessoires:

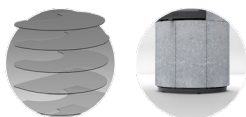

Autres modèles:

M1 ecoLine
M2 ecoLine
M3 ecoLine

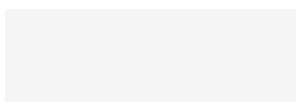

M Basic ecoLine

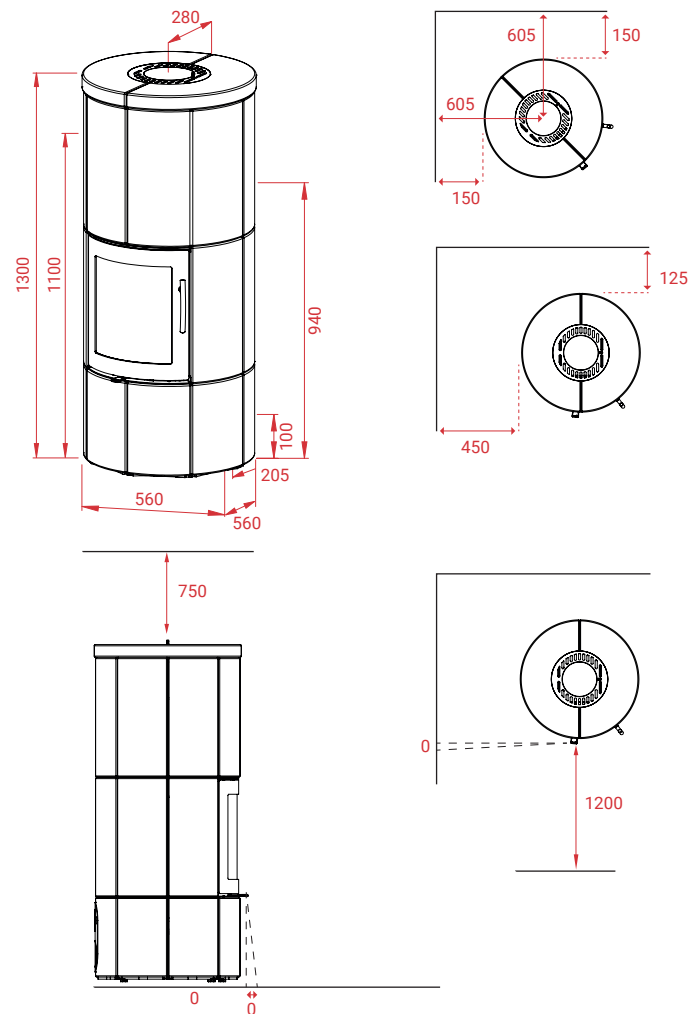

En savoir plus:



LOTUS HEATING SYSTEMS A/S

+45 6323 7070

info@lotusstoves.com

www.lotusstoves.com



M1 Pierre ollaire ecoLine



Caractéristiques techniques:

KG	370 kg
12 PA	12 PA
5,5 kW	5,5 kW
30-120 m²	30-120 m²
Mg/M³	12
1,55 kg	1,55 kg
86/76 %	86/76 %

M1 Pierre ollaire ecoLine

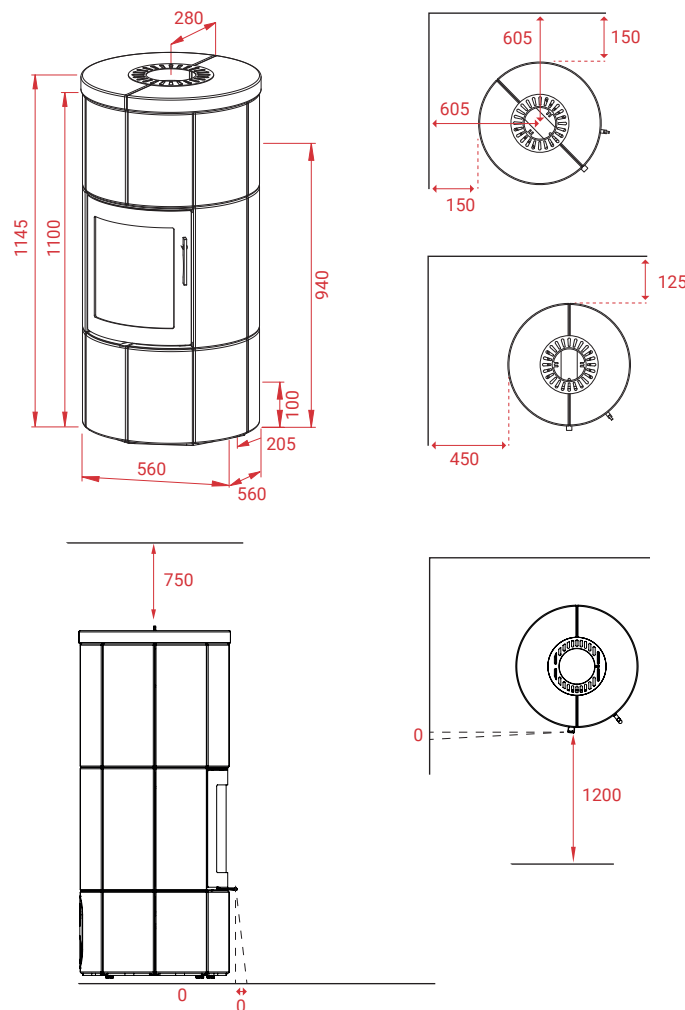

Accessoires:

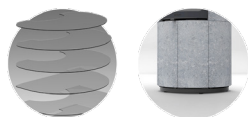

Autres modèles:

- M Basic ecoLine
- M2 ecoLine
- M3 ecoLine

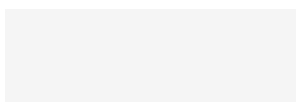

En savoir plus:



LOTUS HEATING SYSTEMS A/S

+45 6323 7070

info@lotusstoves.com







www.lotusstoves.com



M1 Indian Night ecoLine



Caractéristiques techniques:

 KG	370 kg
 12 PA	12 PA
 5,5 kW	5,5 kW
 30-120 m²	30-120 m²
Mg/M³	12
 1,55 kg	1,55 kg
 86/76 %	86/76 %

M1 Indian Night ecoLine

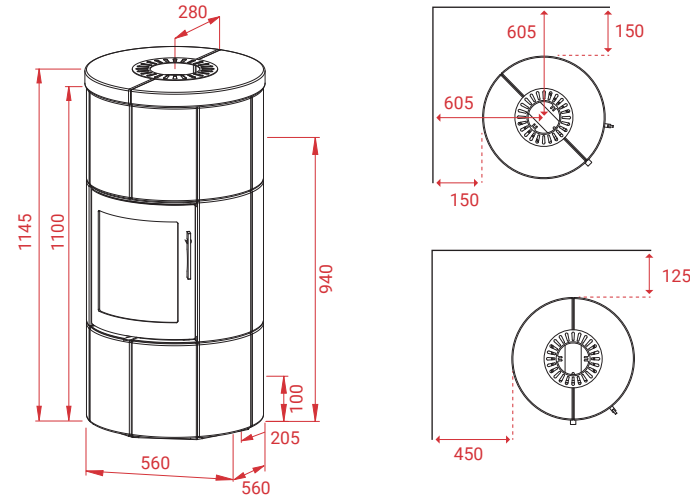

Accessoires:

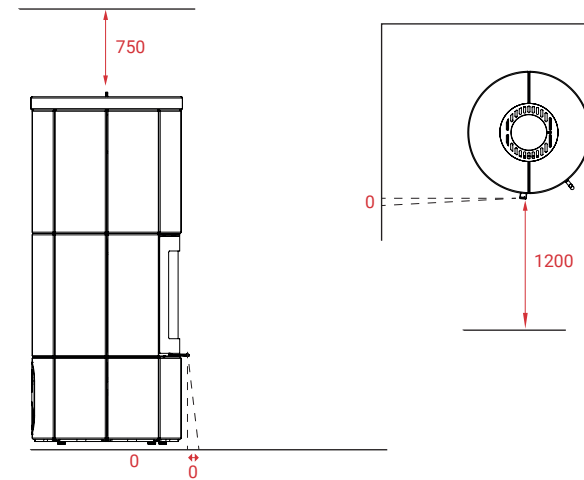
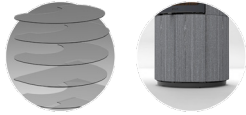

Autres modèles:

- M Basic ecoLine
- M2 ecoLine
- M3 ecoLine

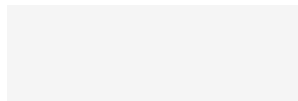

En savoir plus:



LOTUS HEATING SYSTEMS A/S

+45 6323 7070

info@lotusstoves.com

www.lotusstoves.com



M2 Pierre ollaire ecoLine



Caractéristiques techniques:

KG	497 kg
	12 PA
	5,5 kW
	30-120 m ²
Mg/M³	12
	1,55 kg
	86/76 %

Accessoires:

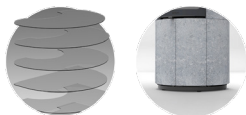

M2 Pierre ollaire ecoLine

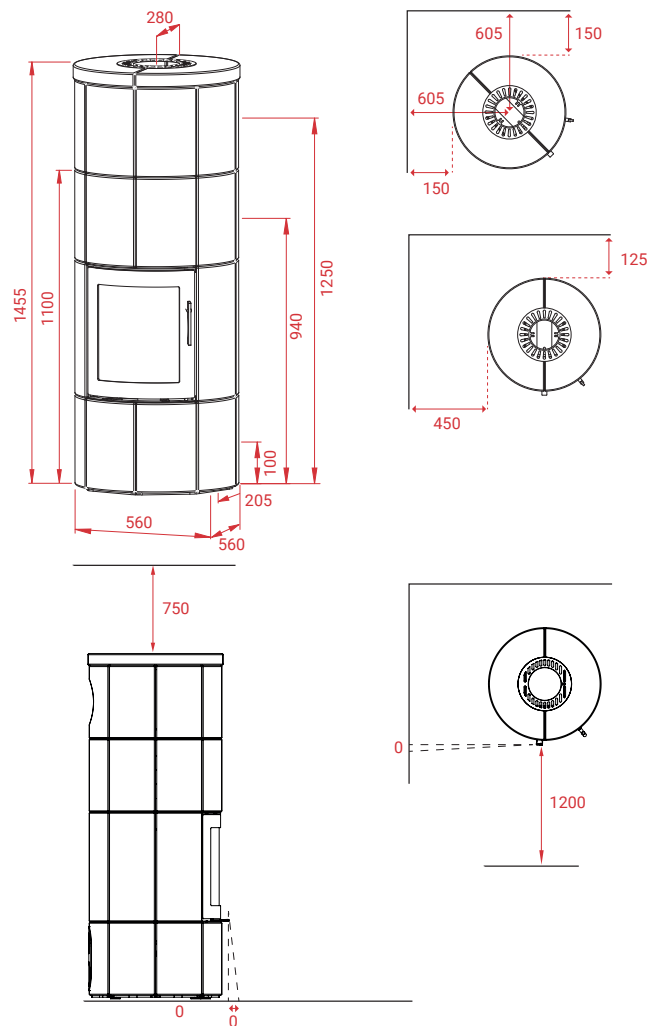

Autres modèles:

- M Basic ecoLine
- M1 ecoLine
- M3 ecoLine

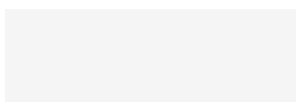

En savoir plus:



LOTUS HEATING SYSTEMS A/S

+45 6323 7070

info@lotusstoves.com







www.lotusstoves.com



M2 Indian Night ecoLine



Caractéristiques techniques:

 KG	497 kg
 12 PA	12 PA
 5,5 kW	5,5 kW
 30-120 m²	30-120 m²
Mg/M³	12
 1,55 kg	1,55 kg
 86/76 %	86/76 %

Accessoires:

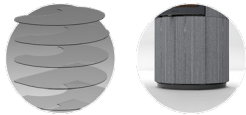

M2 Indian Night ecoLine

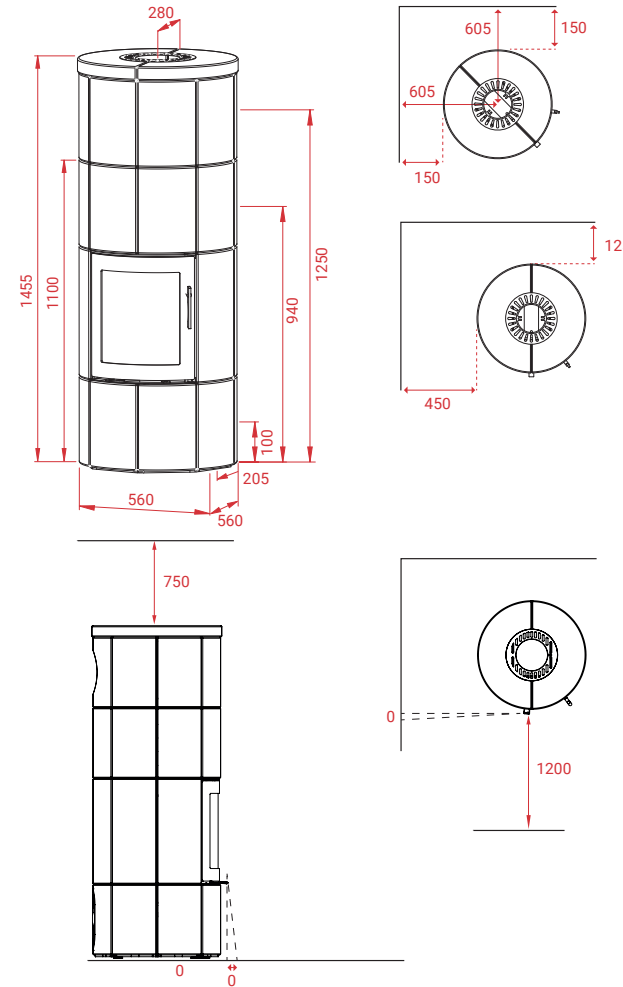

Autres modèles:

- M Basic ecoLine
- M1 ecoLine
- M3 ecoLine

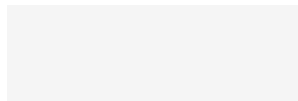

En savoir plus:



LOTUS HEATING SYSTEMS A/S

+45 6323 7070

info@lotusstoves.com







www.lotusstoves.com



M3 Pierre ollaire ecoLine



Caractéristiques techniques:

 KG	625 kg
 12 PA	12 PA
 5,5 kW	5,5 kW
 30-120 m²	30-120 m ²
Mg/M³	12
 1,55 kg	1,55 kg
 86/76 %	86/76 %

Accessoires:

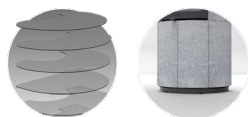

M3 Pierre ollaire ecoLine

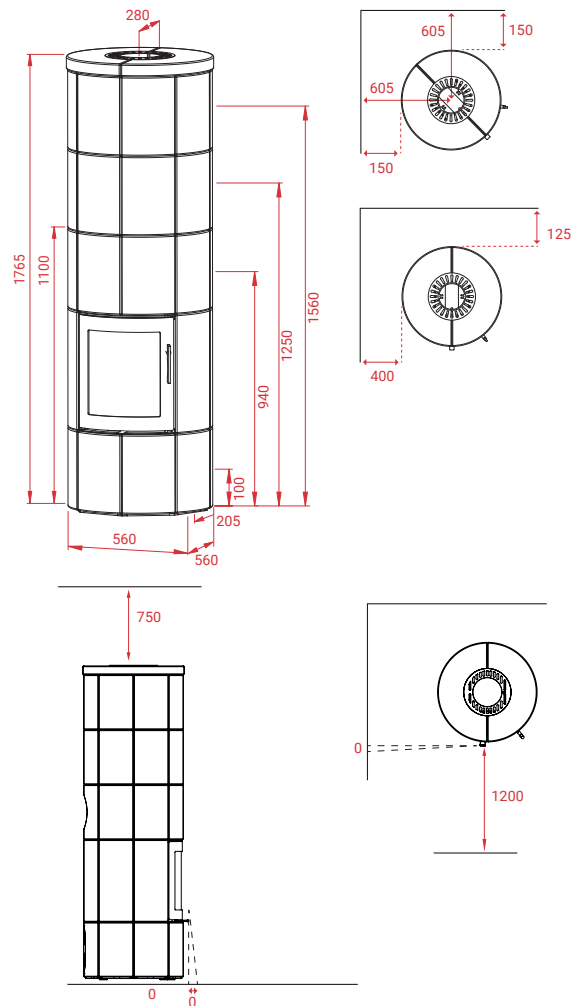

Autres modèles:

M Basic ecoLine
M1 ecoLine
M2 ecoLine

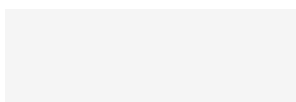

En savoir plus:



LOTUS HEATING SYSTEMS A/S

+45 6323 7070

info@lotusstoves.com







www.lotusstoves.com



M3 Indian Night ecoLine



Caractéristiques techniques:

 KG	625 kg
	12 PA
	5,5 kW
	30-120 m ²
Mg/M³	12
	1,55 kg
	86/76 %

Accessoires:

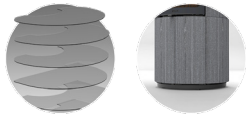

M3 Indian Night ecoLine

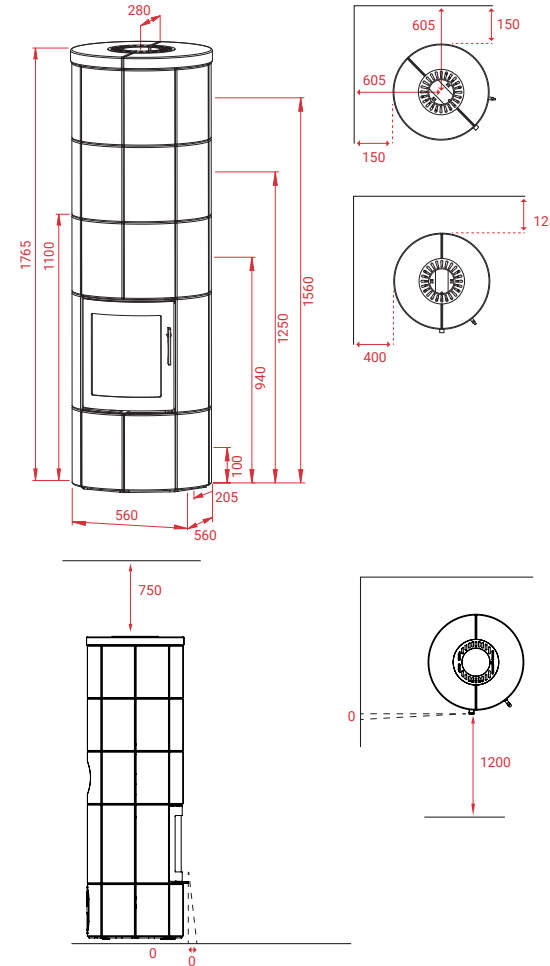

Autres modèles:

M Basic ecoLine
M1 ecoLine
M2 ecoLine

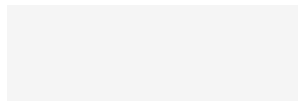

En savoir plus:



LOTUS HEATING SYSTEMS A/S

+45 6323 7070

info@lotusstoves.com

www.lotusstoves.com

